

38 555 000 **RAPID SL FOR WASH BASIN**

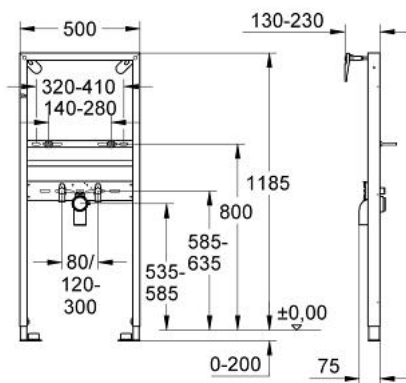

PRODUCT DESCRIPTION

- for single hole installation
- 1.20 m installation height
- for on-the-wall installations or studded walls
- powder coated steel frame, self-supporting
- for dry-cladding, completely pre-assembled
- with fixed connections
- quick adjustment, lockable
- fixing material
- TÜV approved
- wash basin fixing bolts M10 with fixing device for ceramic
- variable distance of fixing bolts
- HT-outlet bend \varnothing 50 mm
- seal \varnothing 32 mm
- 2 noise protected fitting connections 1/2"
- accessories for on-the-wall installation

38 555 000 **RAPID SL FOR WASH BASIN**

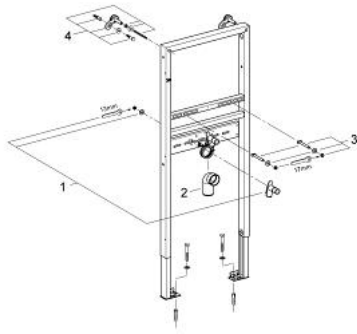

SPARE PARTS, 11月 2008 – now

- 1: Fitting connection (Spare part-nr. 42944000)
- 2: Outlet elbow 2" (Spare part-nr. 42943000)
- 2.1: Holder for outlet elbow (Spare part-nr. 42236000)
- 3: Threaded bolt (Spare part-nr. 42247000)
- 4: Wall brackets (Spare part-nr. 3855800M)